



Umgestaltung des Ernst-August-Platzes

zwischen
Kurt-Schumacher-Straße und
Joachimstraße

Öffentliche Sitzung

Stadtbezirksrat Mitte

16. Dezember 2019 um 18.30 Uhr im
Hodlersaal, Neues Rathaus

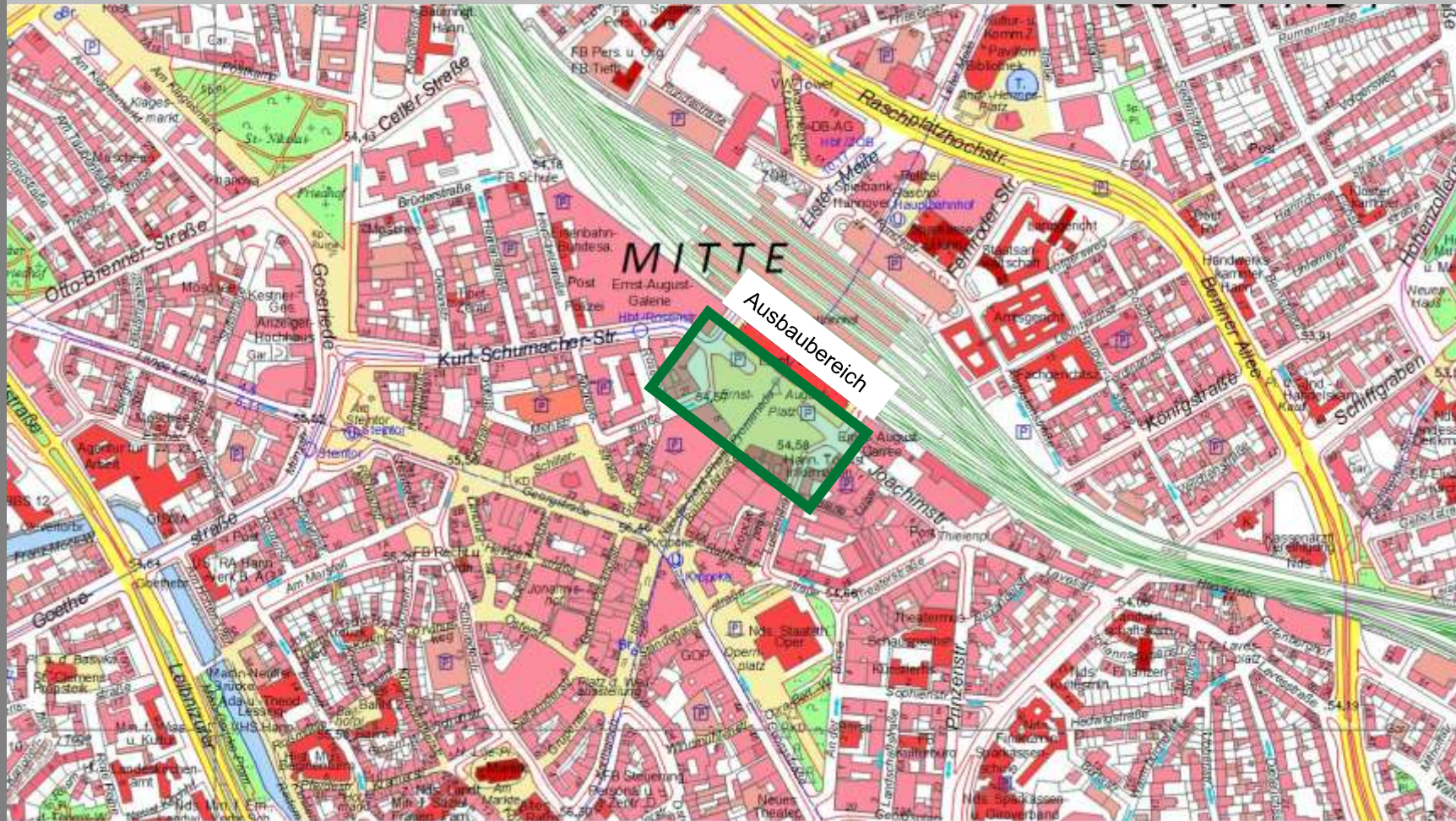



Luftbild

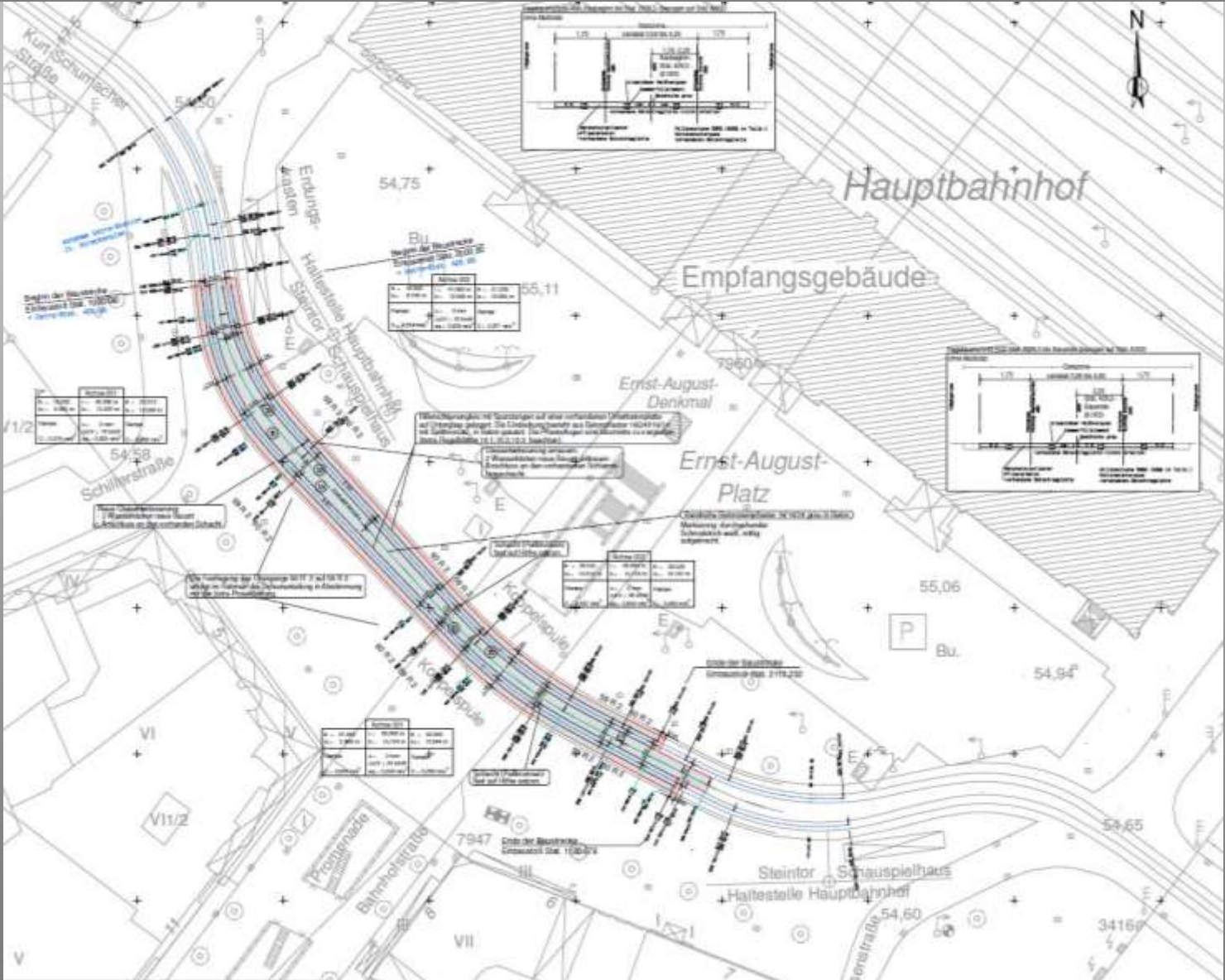

Stadtbahnstrecke D-West | Grunderneuerung in Bestandslage

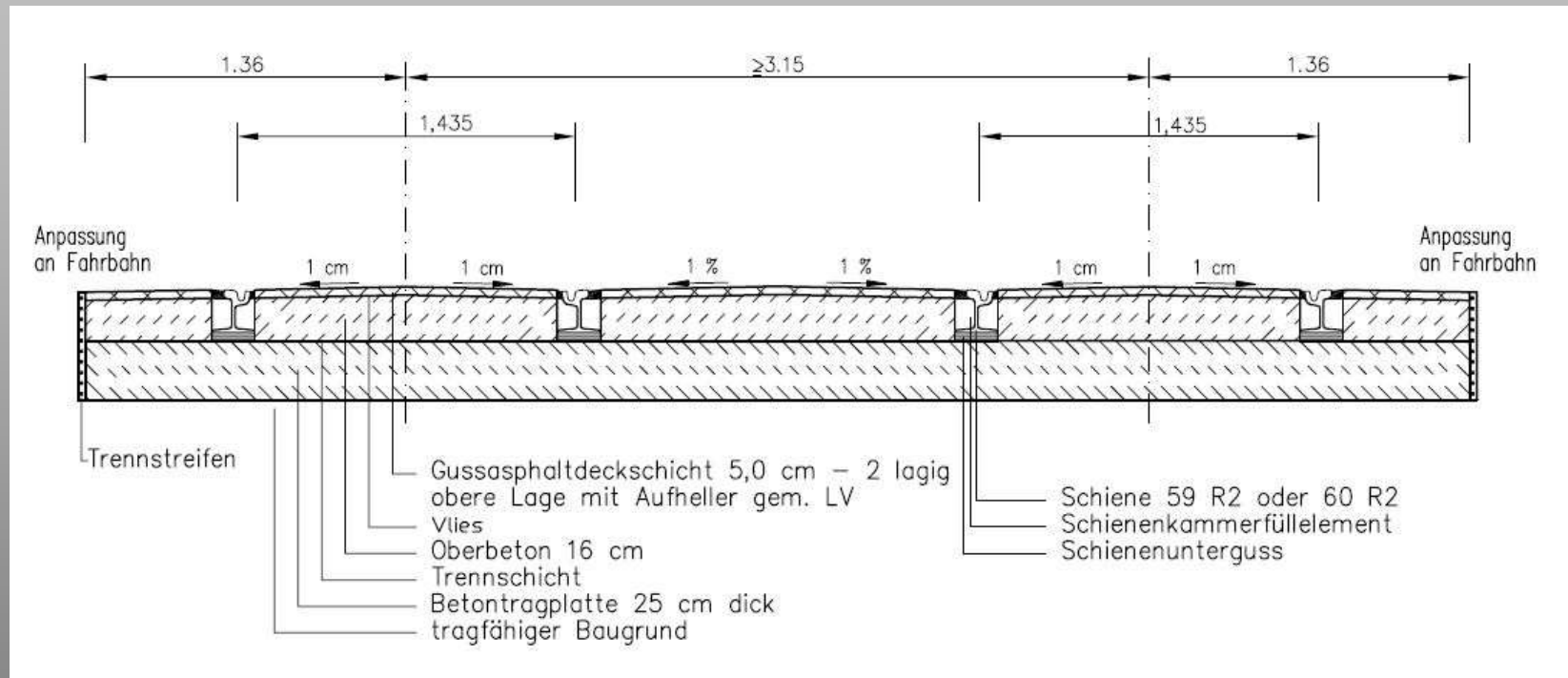





Bestandsfotos

Haltestelle
Blick Richtung Luisenstraße

Haltestelle
Blick Richtung Tunnel Lister Meile



Gleisbereich
Blick Richtung HBF



Gleisbereich
Blick Richtung Luisenstraße

Bestandsfotos

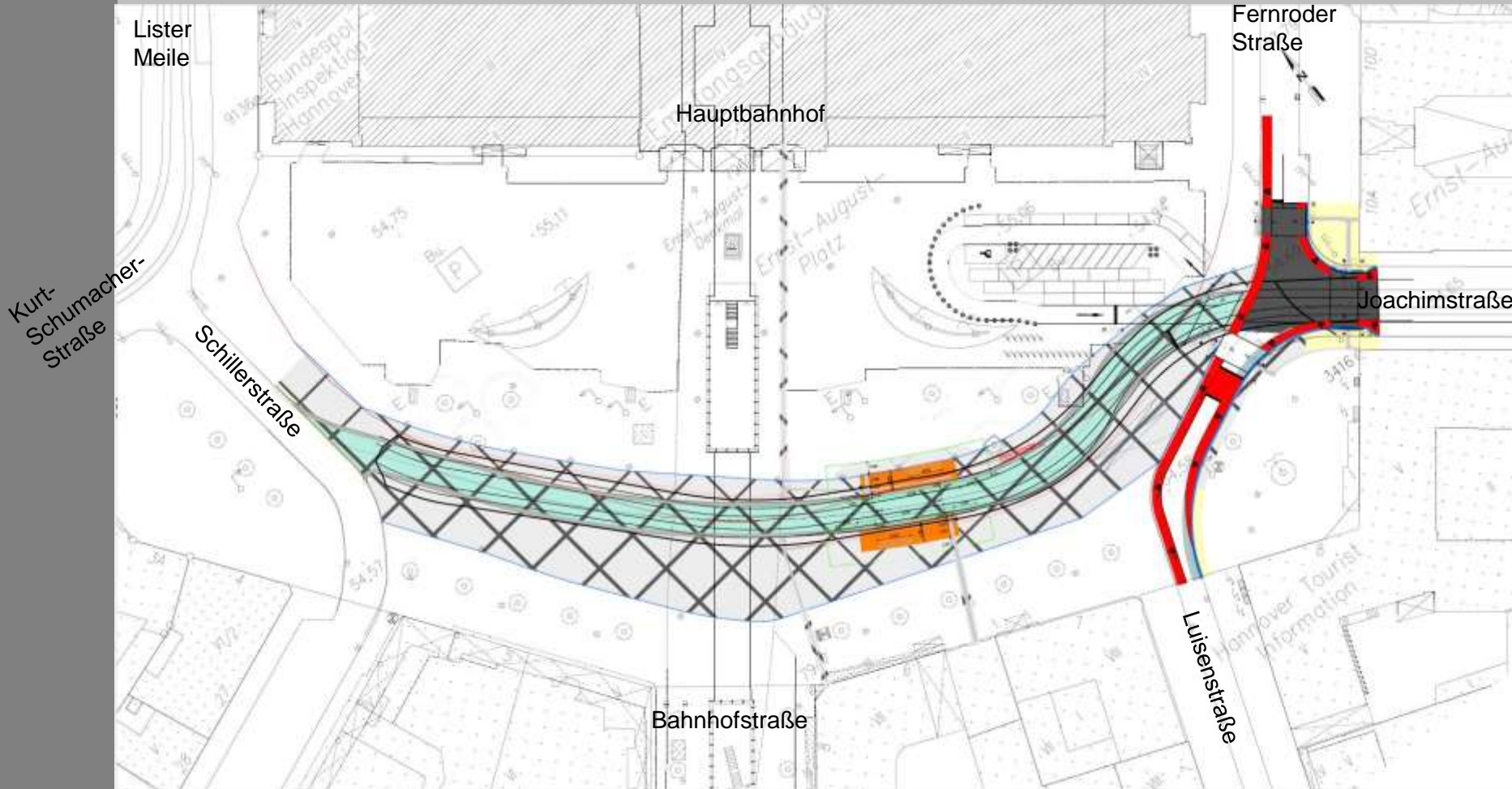

Planung: Rückbau der Gleisbereiche; Barrierefreier Ausbau der Bushaltestelle Ernst-August-Platz

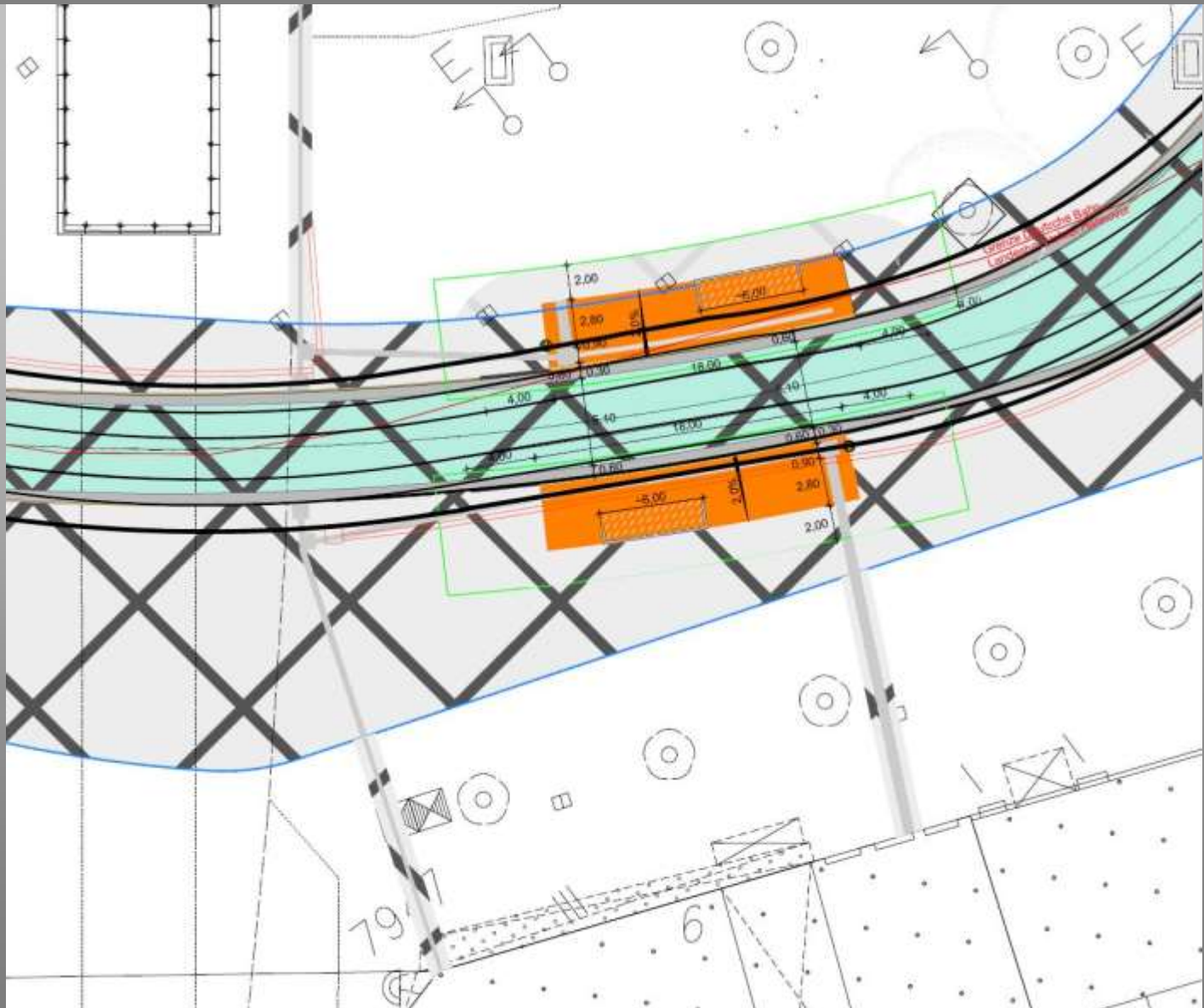

Planung barrierefreie Bushaltestelle

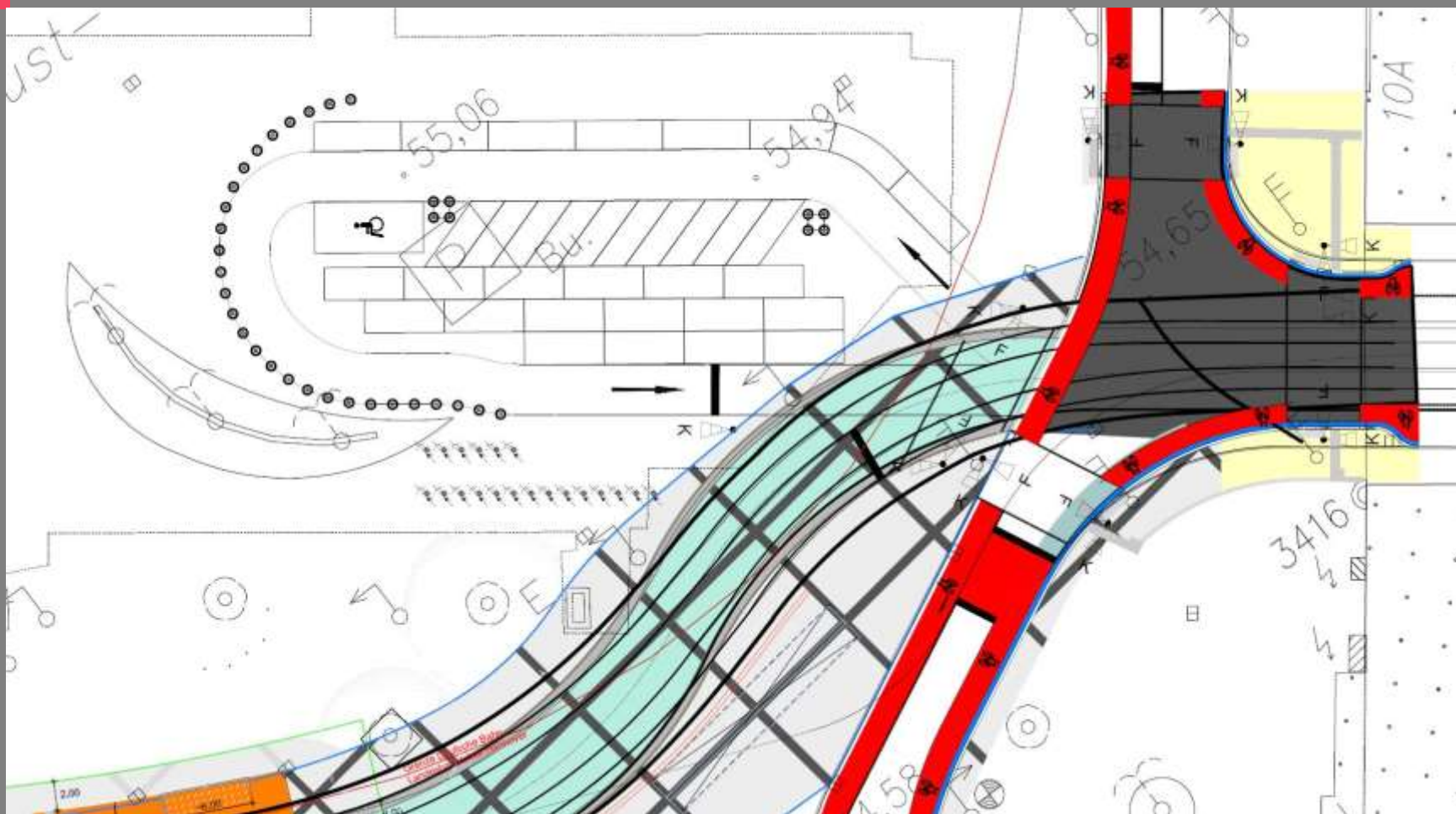

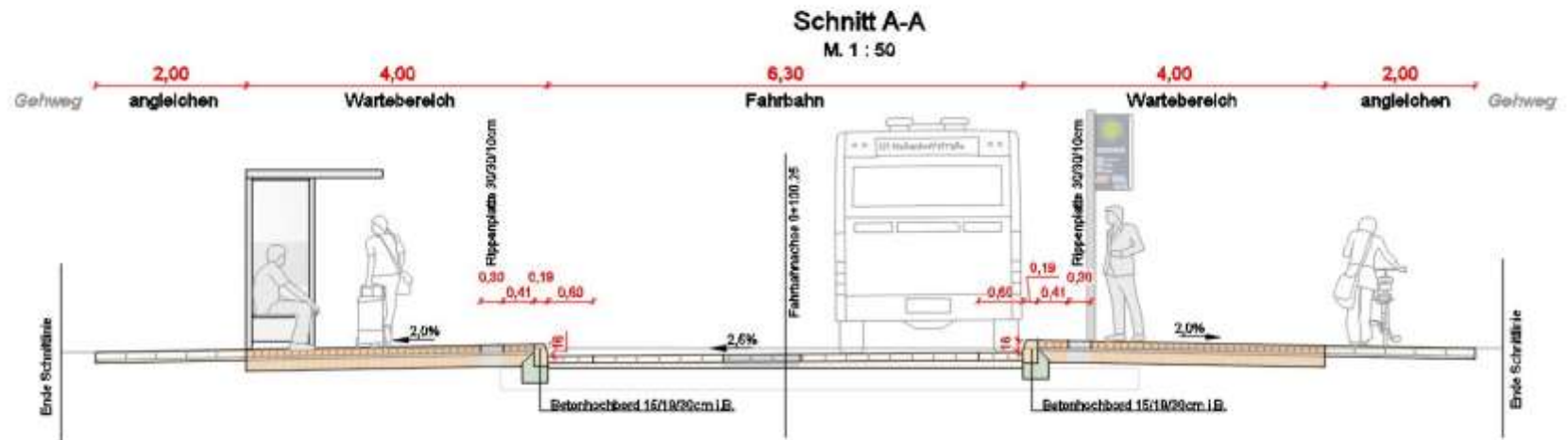



- Vielen Dank für Ihre Aufmerksamkeit -

Fachbereich Tiefbau
16. Dezember 2019